



# EcoSEC - semi-micro GPC/SEC system for high throughput polymer analysis



**TOSOH BIOSCIENCE**

## ABOUT TOSOH BIOSCIENCE GMBH

Tosoh Bioscience is an acknowledged global leader in the field of liquid chromatography with a focus on bio-separations. Established as TosoHaas in 1987, the original joint venture between Tosoh Corporation, Japan, and Rohm and Haas, USA, has become synonymous with advanced products and quality support.

In the year 2000 it became a wholly-owned subsidiary of Tosoh Corporation with sales, marketing, and technical service offices in the U.S., Germany, and Japan. To unify all affiliates and better reflect the markets served, the name was changed to Tosoh Bioscience in 2002.

Tosoh Bioscience offers solutions for research, drug discovery, clinical chemistry, environmental analysis, manufacturing and other industrial applications. The product portfolio encompasses a comprehensive line of media and prepacked HPLC columns for all modes of liquid chromatography and GPC instruments.

Our state of the art manufacturing sites in Japan provide products to the sales and support network across the world. Tosoh Bioscience's European headquarters (Separations Business Unit) are located in Stuttgart, Germany, with customer service and supply chain in Tessenderlo, Belgium. The markets served comprise Europe, Middle East, Africa and India.

Tosoh has a long and successful history in manufacturing instruments for gel permeation chromatography (GPC) for the Asian market. Based on the wide experience in GPC instrument design and GPC column technology, Tosoh has developed the new EcoSEC system to meet the market demands for high throughput, semi micro GPC.



## ABOUT PSS POLYMER STANDARDS SERVICE

### GMBH

Polymer Standards Service GmbH (PSS) is an acknowledged leader in the field of polymer analysis and synthesis. PSS is offering supplies and services for comprehensive characterization of natural and synthetic macromolecules.

The product portfolio comprises columns, certified reference standards and software for Gel Permeation Chromatography/Size Exclusion Chromatography (GPC/SEC) and dedicated systems for specific applications including viscosity and light scattering detectors. In addition to GPC software, systems and consumables, PSS offers analytical services.

A team of chemists with extensive knowledge and practical experience in synthesis, characterisation and properties of natural and synthetic polymers is able to find answers and solutions to all questions related to polymers.

## ABOUT THE COOPERATION BETWEEN TOSOH BIOSCIENCE AND PSS

Tosoh Bioscience and PSS have established an alliance to promote and distribute Tosoh Bioscience GPC instruments in the European market. In Europe EcoSEC is distributed through PSS.

**EcoSEC - THE WORLD'S FIRST SEMI-MICRO GPC/SEC SYSTEM FOR HIGH THROUGHPUT POLYMER ANALYSIS**

**ECOSEC FEATURES & BENEFITS**

- **Compact, low dead volume GPC/SEC system**
- **Outstanding performance at short analysis times**
- **Designed for semi-micro GPC, thereby saving solvent, waste disposal costs and analysis time**
- **Fully controlled by PSS WinGPC Unity software**

Gel permeation chromatography / size exclusion chromatography (GPC/SEC) is a well known technique for the separation of macromolecules like natural and synthetic polymers. It is the method of choice for the characterization of polymer molecular weight and molecular weight distribution. Tosoh Bioscience is a leading manufacturer of SEC/GPC columns and developed GPC instruments for the Asian market for more than 5 years.

EcoSEC is a compact, all-in-one system with refractive index detection for fast, high resolution, semi-micro GPC at temperatures below 60°C.

It comprises a dual pump precision solvent delivery system, an automatic injector, a column oven and a high performance dual flow refractive index detector as standard (Figure 1).

EcoSEC can be equipped with additional detectors like UV, light scattering and viscosity detectors.

The EcoSEC GPC system is engineered to minimize extra column dead volume. This allows the use of smaller columns such as the TSK-GEL SuperMultiporeHZ semi-micro GPC columns. These columns are 4.6 mm ID x 15 cm L and consume about one sixth of the solvent compared to conventional systems and columns. In addition, run times are often half that of larger columns. At the same time semi-micro GPC often improves resolution and signal to noise levels.

Figure 2 shows the separation of Polytetramethylene ether glycol (PTMEG) using EcoSEC with a semi-micro column compared to a conventional GPC analysis.

➤ **FIGURE 1**

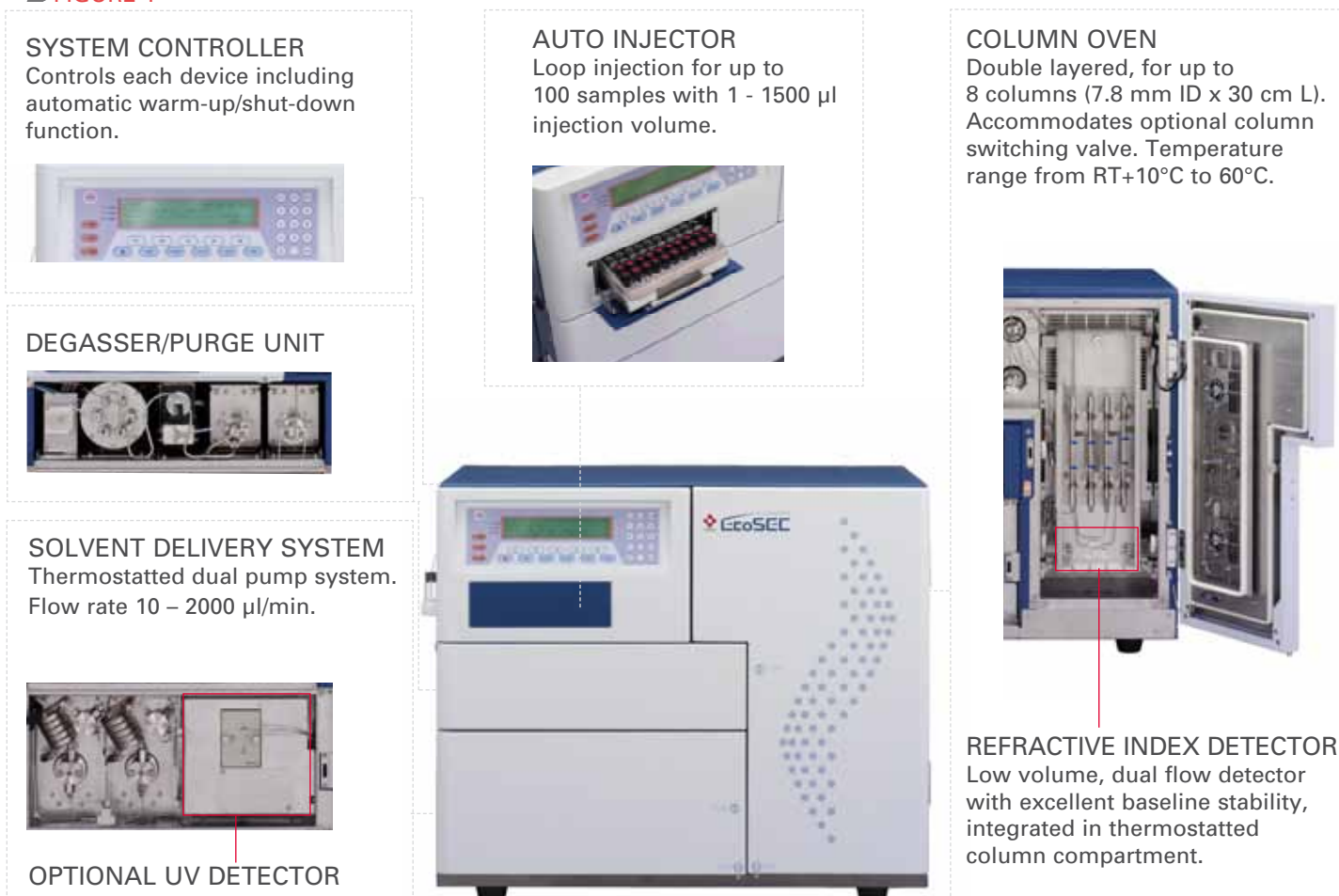

**FIGURE 2**

**GPC ANALYSIS OF PTMEG**

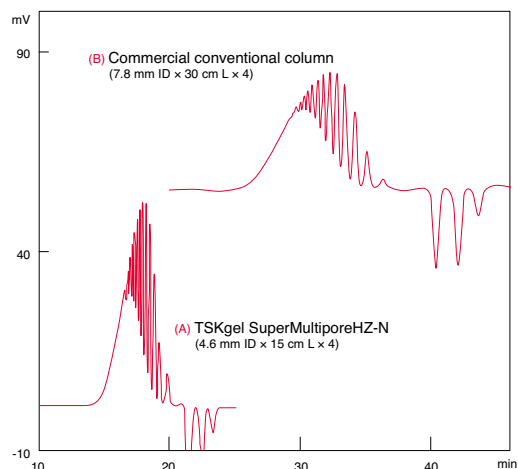

Column: TSKgel SuperMultiporeHZ-N  
 Eluent: THF  
 Flow rate: A: 0.35 ml/min; B: 1 ml/min  
 Temperature: 40°C  
 Detection: RI  
 Inj. volume: A: 10 µl; B: 60 µl

**SOLVENT DELIVERY SYSTEM**

The EcoSEC micro plunger pumps are precisely temperature controlled by a separate oven, to provide exactly the same flow rate (10 µl/min – 2 ml/min) even when the laboratory temperature fluctuates. The high flow rate precision of +/- 0.2% will not be affected by room temperature changes regardless of the kind of solvent used for GPC. The integrated degasser can be switched between



two capacities to shorten start-up time. The solvent delivery compartment offers enough space to accommodate the optional UV detector.

The pumps employ advanced check valve design and state of the art flow control. The result is a constant flow rate from run to run and from day to day (Figure 3).

**FIGURE 3**

**RETENTION TIME STABILITY**

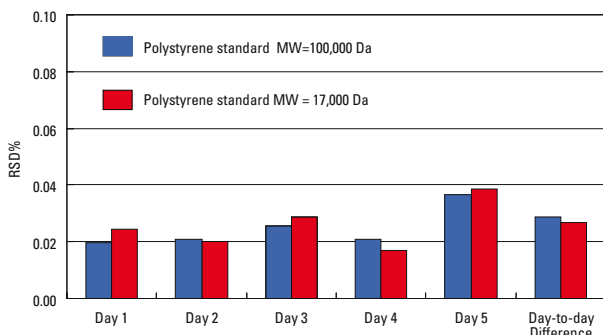

Although GPC separations are typically performed in isocratic mode, EcoSEC incorporates two pumps. The additional pump contributes to the excellent baseline stability of the RI detector by delivering preheated eluent to the detector's reference cell (Figure 4).

**AUTOINJECTOR**

The automatic injector has a capacity of 100 sample vials, covering the needs of high throughput semi-micro GPC analysis. The injection volume can be selected in a range from 1 µl to 1.5 ml.



**COLUMN OVEN**

The column oven provides excellent thermal stability for up to eight GPC columns in a dual layer as well as for the refractive index detector cell. The oven can accommodate an optional column switching valve in the upper part. Temperature settings range from ambient plus 10°C to 60°C.



**REFRACTIVE INDEX DETECTOR**

Based on a dual flow line design and high performance thermostatisation the refractive index (RI) detector provides unmatched baseline stability. The detector is positioned in the lower part of the column oven, next to the column outlet. In addition to the optimized flow line design, the low volume of the RI detector cell (2.5 µl) minimizes extra column peak broadening. All together essential premises for any system supposed to be used with high resolution, semi-micro GPC columns.

**FIGURE 4**

**REPRODUCIBLE ANALYSIS WITH DUAL FLOW RID**

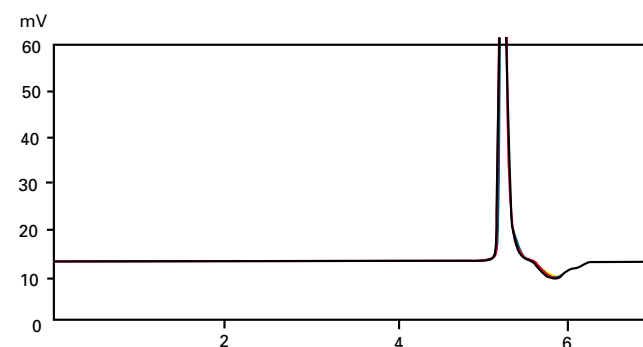

## WinGPC UNITY CHROMATOGRAPHIC DATA SYSTEM

The EcoSEC GPC system is fully controlled by the well known PSS WinGPC Unity data system. WinGPC Unity combines all kinds of SEC/GPC applications for synthetic, natural and biopolymers:

- Molar mass determination (MWD, molar mass averages Mn, Mw, Mz, polydispersity)
- Quantification and identification of sample compounds
- Analysis of aggregation states, association and gel content
- In-depth elucidation of molecular and structural properties

### METHOD SETUP

Configuration of pertinent instrument components like pumps, autoinjector, columns, integrated RI detector and optional detectors like UV, viscosity and light scattering detectors is performed by drag and drop. All resources can be managed easily. A simple click on element icons is enough to set instrument properties and parameters. Figure 5 shows the integrated software module SystemPilot, the EcoSEC instrument manager.



The HPLC mode simultaneously quantifies HPLC and SEC/GPC results, i.e., molecular weight distribution or the amount of polymer, residual monomer and additives.

### GAIN INCREASED KNOWLEDGE

WinGPC Unity facilitates data transfer and allows automatic calibration and recalibration. It provides a wide selection of calibration methods computed with proprietary calibration fit routines that yield high accuracy and precision: Calibration with narrow standards, universal calibration with Mark-Houwink constants, broad standards calibration and cumulative match calibration are provided with step-by-step guides that assure integrity of process.

### FLEXIBLE REPORTING

WinGPC Unity offers multiple ways to manage reports and distribute the information:

- Direct printout of highlighted windows
- Export of graphics
- Data transfer to LIMS
- Electronic reports in various formats

The optional WinGPC Unity Report Designer provides all tools to achieve complete control on the design and content of the report.

➤ FIGURE 6

### WIN GPC DATA EVALUATION

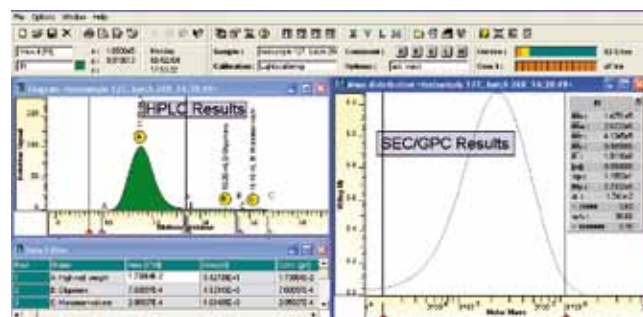

➤ FIGURE 5

### ECOSEC SYSTEMPILOT MODULE

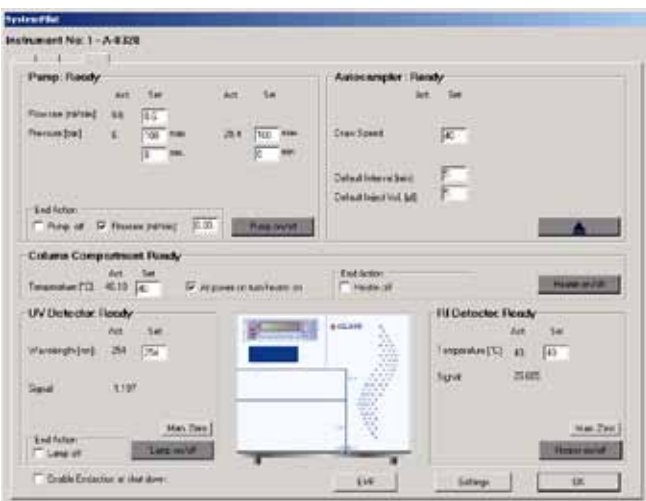

### POWERFUL DATA EVALUATION

WinGPC Unity's data processing tools are designed to optimize workflow for both, QC and R&D environments. It supports manual and automatic data processing with optional internal standard correction and flexible multi-peak evaluation (Figure 6).

## SYSTEM OPTIONS

### COLUMN SWITCHING VALVE

The optional 2-position column switching valve expands the operational flexibility of the EcoSEC GPC system. It allows running sample through one column while equilibrating the second one. Switching the valve puts column #2 in line with the injector so that column #1 is equilibrating.

**FIGURE 7**

### WINGPC DATA EVALUATION

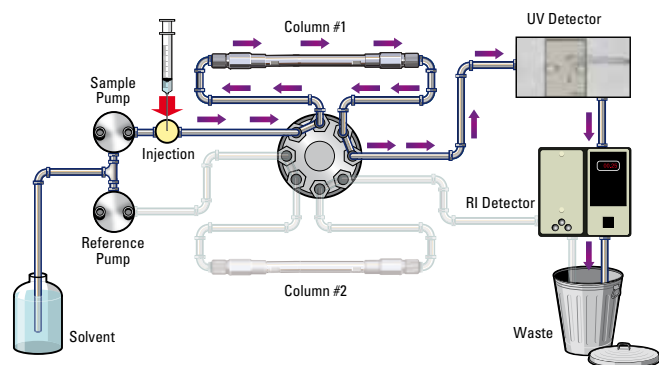

### UV-8320 UV DETECTOR



The optional UV-8320 detector can be installed inside the EcoSEC housing, close to the column outlet and the inlet of the refractive index detector. It covers a wavelength range from 195 to 350 nm.

The detector cell volume is minimized to 2 microliters to reduce peak broadening. This contributes to the high performance of EcoSEC when used for high resolution, semi-micro GPC.

### ETA2010 DIFFERENTIAL VISCOMETER



On-line viscometers are used in GPC analysis to determine the intrinsic viscosity of the sample.

Coupling the ETA2010 viscometer to the EcoSEC GPC system incorporating a RI detector as standard enables comprehensive polymer analysis according to a universal calibration.

True molecular weight and its distribution, size, structure, branching and aggregation of synthetic, natural, and bio-polymers in solution can be characterized.

The ETA2010 differential viscosity detector is designed to meet the requirements of modern GPC applications. Low-noise electronics combined with high-sensitivity pressure transducers as well as superior sample path design results in an excellent detection limit and high signal linearity.

The PSS WinGPC software allows seamless integration of the ETA2010 and the EcoSEC GPC system into one well known user interface.

### SLD7000 MULTI ANGLE LIGHT SCATTERING DETECTOR

Static laser light scattering (SLS) is an absolute method for molar mass determination. It facilitates the direct determination of the characteristic properties of the macromolecular species without previous calibration or any other type of comparison.



The multi angle light scattering photometer SLD7000 for polymer analysis represents the latest development in light scattering and can be combined with the EcoSEC GPC system. Control of the complete system and GPC data analysis is integrated via PSS WinGPC software.

The SLD7000 uses latest technology in optics and electronics to ensure easy and reliable characterization of dilute macromolecular solutions by light scattering. It is ideal for studying synthetic, natural and bio-polymers in solution, including proteins and polysaccharides.

Molar mass, molar mass distribution, radius of gyration, branching, degradation, aggregation, complex formation, nano structures, stability or conformation can be determined without any assumptions.

In Europe, EcoSEC is distributed through PSS Polymer Standards Service GmbH.  
For qualified advisory service concerning applications and system configurations and for detailed quotations, please contact PSS:

PSS Polymer Standards Service GmbH  
In der Dalheimer Wiese 5, 55120 Mainz  
T: +49 (0) 6131-96239-0  
F: +49 (0) 6131-96239-11  
e-mail: [info@polymer.de](mailto:info@polymer.de)  
[www.polymer.de](http://www.polymer.de)

#### Ordering Information:

Part #	Product Description
406-0001	<b>EcoSEC GPC Instrument</b> Includes: Pump Assembly, Autosampler, Column Oven, RI Detector
406-0002	<b>EcoSEC UV-8320 UV Detector</b>
406-0003	<b>EcoSEC Column Switching Valve</b>
406-0101	<b>EcoSEC GPC Standard System</b> Includes: Pump Assembly, Autosampler, Column Oven, RI Detector, Software, UDC810-2 Interface
406-0102	<b>EcoSEC GPC Biopharm System</b> Includes: Pump Assembly, Autosampler, Column Oven, RI Detector, Software, UDC810-2 Interface, Compliance Pack
406-0103	<b>EcoSEC GPC Triple<sup>+</sup> System</b> Includes: Pump Assembly, Autosampler, Column Oven, RI Detector, Viscosity Detector, Multi-angle Light Scattering Detector, Software, UDC810-6 Interface
400-0073	<b>WinGPC Unity Macromolecular Chromatography Data System</b>
400-1010	<b>WinGPC EcoSEC System Pilot</b>
400-1011	<b>Compliance Pack for all EcoSEC Systems</b>
400-1001	<b>WinGPC Report Designer</b>
400-1004	<b>WinGPC MALLS Light Scattering Detection Module</b> Absolute determination of Mn, Mw, Mz, Rg(n,w,z), Ks, as, g & dn/dc
400-1002	<b>WinGPC Viscosity Detection Module</b> Measures intrinsic viscosity, true molar masses, Mn, Mw, Mz, K& g'
402-0001	<b>ETA2010 Differential Viscometer</b> Temperature control up to 80°C
403-0001	<b>SLD7000 Multi Angle Light Scattering Detector</b>
403-0004	<b>Temperature Controlled Cell for SLD7000, up to 80°C</b>



**TOSOH**

**TOSOH BIOSCIENCE**

Zettachring 6, 70567 Stuttgart, Germany  
Tel: +49 (0)711 13257 0 Fax: +49 (0)711 13257 89  
info.sep.eu@tosoh.com [www.tosohbioscience.com](http://www.tosohbioscience.com)