



# MDGC/ GCMS-2010 Series

Shimadzu  
Multi-Dimensional GC/GCMS System





**Multi-Dimensional GC/GCMS System**

# MDGC/GCMS-2010 Series

Shimadzu

Multi-Dimensional GC/GCMS System

## MDGC

A multi-dimensional GC/GCMS system performs separation using two columns that have different characteristics. The system has a mechanism in which the components that are insufficiently separated in the first column they pass through (the "1<sup>st</sup> column") are introduced ("heart-cut") to a second, different column (the "2<sup>nd</sup> column"). This enables analysis with a level of separation that cannot be attained in conventional single-column analysis.

In addition, the precise flow-switching technology, which is supported by a high-precision digital flow controller, ensures heart-cut analysis with a high level of reproducibility.

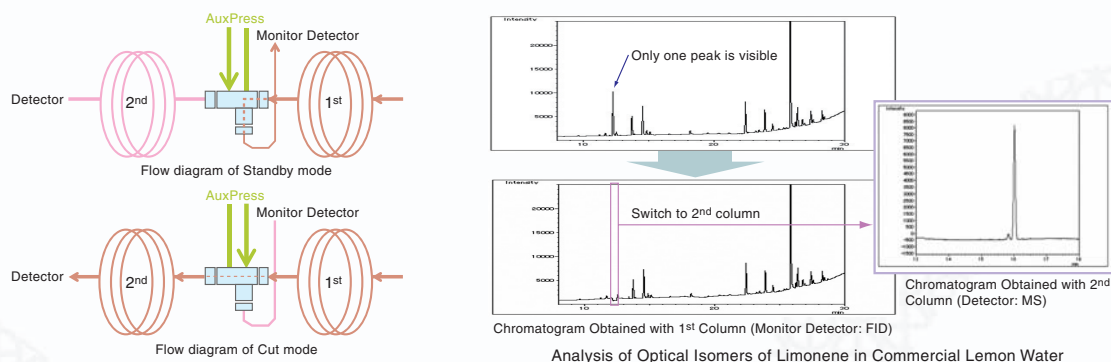

Analysis of Optical Isomers of Limonene in Commercial Lemon Water

## Features



### Optimized High-Performance System

Introduction of a new mechanism Multi-Deans Switching



### Improvement of working efficiency with superior operability

Intuitive Operation Supported by the MDGC control software package MDGCsolution



### A Wide Variety of Optional Systems/ Greater Ease of Maintenance



### Main MDGC Applications

- Analysis of Specific Components in Samples Containing Several Matrices Petroleum products (e.g., gasoline, light oil, and kerosene), aromas (e.g., foods and beverages), and optical isomers
- Analysis of Fine Chemical Products and Impurities in Raw Materials Minute peaks hidden by major components
- Analysis of Harmful Components in Environmental Samples

# Outstanding Retention Time Stability

## Multi-Deans Switching

In the past, samples have been introduced to columns using the switching mechanism known as Deans switching. However, this system results in such problems as a reduced recovery rate and fluctuations in the retention time. The MDGC/GCMS-2010 system incorporates multi-Deans switching, a new mechanism that significantly reduces the likelihood of fluctuations in the retention times of eluted components, even if switching is performed several times.

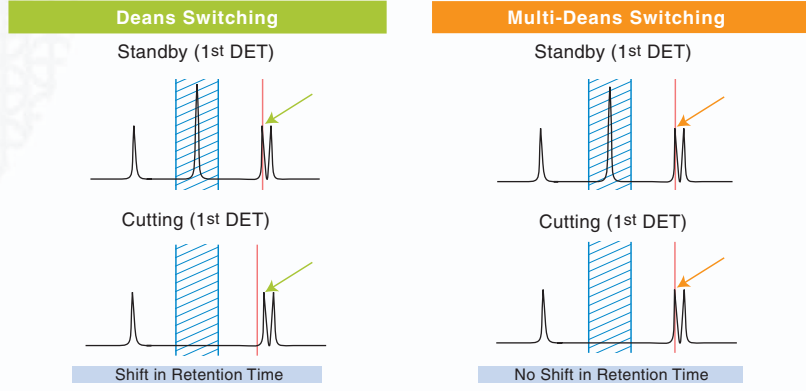

Comparison between Traditional Deans Switching and Multi-Deans Switching

### • Standby Mode

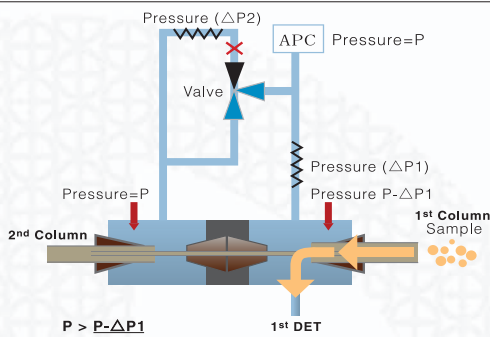

### • Cut Mode

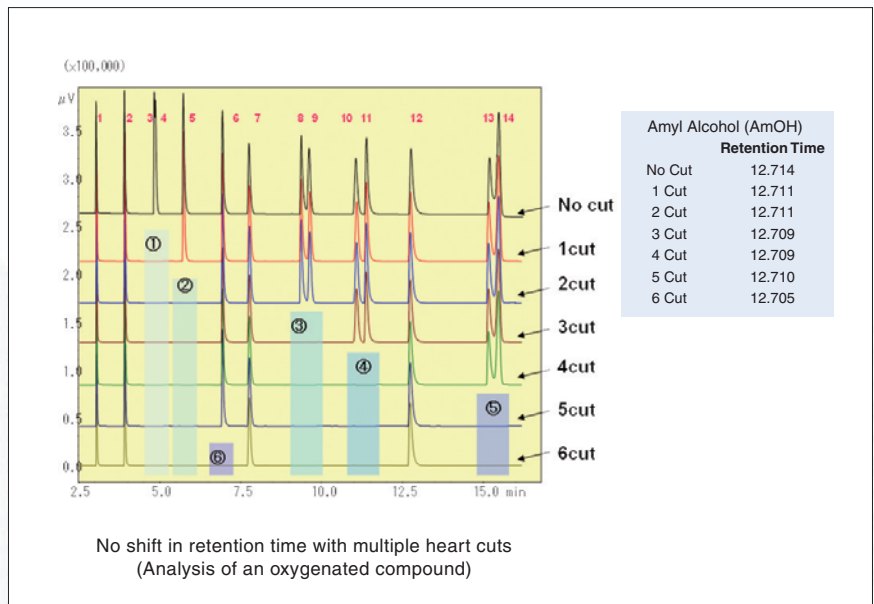
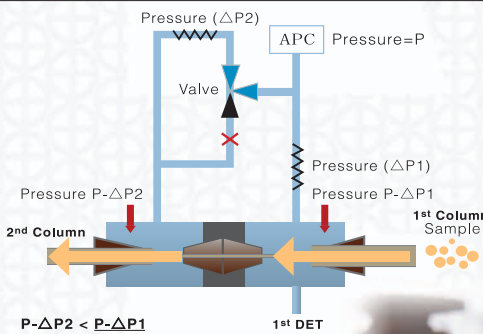

# Handling Quantitative Analysis with Deactivation Processing

## High Reproducibility

The multi-Deans switching mechanism in the MDGC/GCMS-2010 uses a capillary method with a low dead volume. Since the internal surface has been subjected to deactivation processing, even in the analysis of alcohols with a high polarity, the peak form is the same as that obtained in GC analysis. For this reason, a superior level of peak reproducibility is attained, and analysis with a high level of quantitative accuracy is possible.

Also, even after the multi-Deans switching mechanism performs heart-cutting, the retention times of the peaks eluted from the 1st column hardly change. Consequently, a heart-cutting program can be created easily, regardless of the duration of heart-cutting or the number of times it is performed, by specifying times that encompass parts with insufficient separation and target components in the chromatogram obtained with the 1st column without heart-cutting.

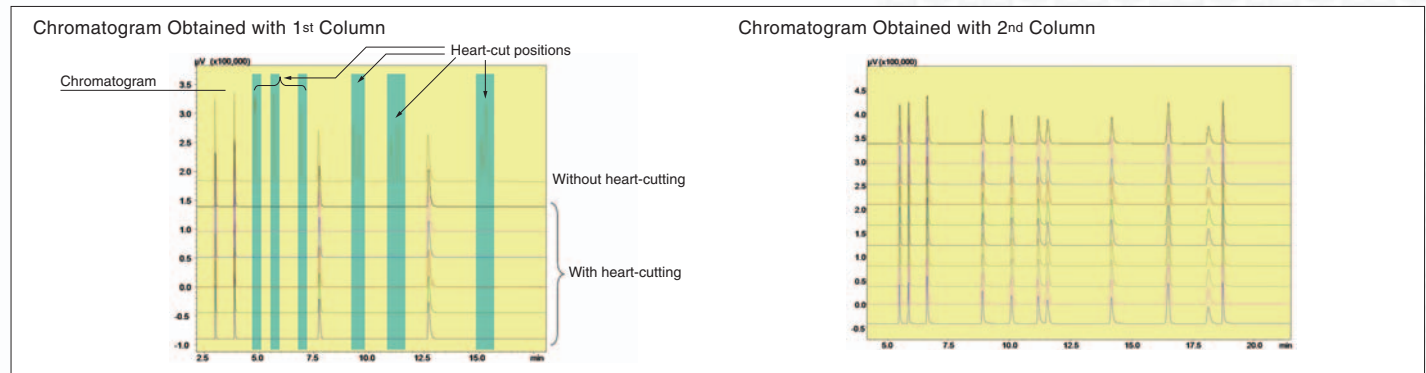

Reproducibility of 1st Column

Compound	Area		Retention Time	
	MeOH	tAmOH	MeOH	tAmOH
1	174308	435368	3.008	12.712
2	171031	427495	3.009	12.712
3	173117	433085	3.009	12.712
4	174715	438180	3.009	12.712
5	172315	430744	3.008	12.712
6	174633	436304	3.008	12.712
7	175269	439073	3.009	12.712
8	175863	441410	3.008	12.711
9	172717	430224	3.008	12.712
10	172002	435496	3.008	12.712
Average	173597	434738	3.008	12.712
STDEV	1582	4347	0.00052	0.00032
CV(%)	0.912	1.000	0.017	0.002

Reproducibility of 2nd Column

Compound	Area						Retention Time					
	Acetone	IPA	ETBE	Bz	TAME	nBuOH	Acetone	IPA	ETBE	Bz	TAME	nBuOH
1	241902	258122	322917	584033	302735	341100	5.515	5.880	11.563	16.501	18.137	18.733
2	237073	253283	316835	572472	296948	334684	5.516	5.880	11.565	16.501	18.136	18.734
3	240294	256361	321149	580369	301337	339373	5.516	5.881	11.565	16.503	18.138	18.733
4	242492	259231	324511	587335	304680	343516	5.515	5.881	11.565	16.502	18.136	18.732
5	238727	254946	318735	576768	299044	337067	5.515	5.880	11.563	16.500	18.136	18.733
6	242091	258606	323204	584763	303246	342028	5.515	5.880	11.563	16.503	18.137	18.732
7	243402	260304	325211	588083	305140	344235	5.515	5.880	11.563	16.502	18.135	18.731
8	241572	260384	326286	588626	301903	337481	5.515	5.880	11.563	16.501	18.135	18.732
9	239256	255374	319324	576796	299153	336898	5.515	5.880	11.563	16.501	18.135	18.733
10	238508	254885	319167	576955	299617	337750	5.515	5.880	11.564	16.502	18.137	18.730
Average	240532	257150	321734	581620	301380	339413	5.515	5.880	11.564	16.502	18.136	18.732
STDEV	2067.56	2506.10	3159.04	5706.12	2662.17	3170.38	0.00037	0.00049	0.00067	0.00076	0.00108	0.00106
CV	0.860	0.975	0.982	0.981	0.883	0.934	0.007	0.008	0.006	0.005	0.006	0.006

## Effect of Deactivation Processing

If standard tubings and unions that have not been subjected to deactivation processing are used for highly degradable components, decomposition and tailing may occur. For example, the chromatogram on the right shows the results obtained for 1-decanol using a switching element that has not been subjected to deactivation processing compared to one that has. With the former, not only did tailing occur, but the decomposition product 1-decylamine was detected. With the latter, hardly any tailing and/or decomposition products were detected.

Also, the use of SilTite® for the connection between the switching element and the capillary column helps prevent the kind of tailing that occurs with conventional Vespel ferrules due to adsorption.

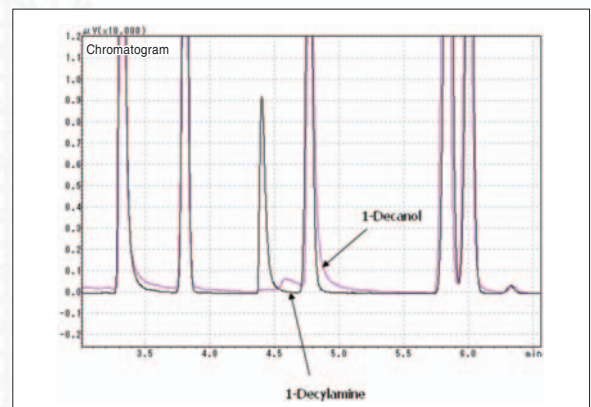

Tailing of Polar Substance (1-Decanol)  
Top: Without Deactivation Processing; Bottom: With Deactivation Processing

# Superior Intuitive Operability

## MDGC/GCMS-2010 system

Multi-Deans switching

AFC • APG

MDGCsolution

High-Separation

Reproducibility

Operability

Structure analysis  
GC-GCMS System

Quality control  
GC-GC System



## Excellent Peak Picking Capability

The majority of the work involved in MDGC analysis consists of determining the analytical conditions and switching timing that allow the target components to be separated. For this reason, the software's operability has a great influence on work efficiency.

The MDGC control software package, MDGCsolution, makes it possible to set the analytical conditions for both the 1st GC and 2nd GC or GCMS together. As a result, it is not necessary to switch between several different software products in order to make fine adjustments to the analytical conditions.

The conditions for batch processing can also be set together, and because the window configuration and operating style are the same as

those of GCsolution and GCMSsolution, intuitive operation is possible. One important feature of MDGCsolution is that it allows the switching settings to be performed while viewing the chromatogram. If you move the cursor near a peak to be heart-cut on the chromatogram and double-click, the switching is set in units of 0.01 minutes. Because operation is this simple, hardly any time is required when performing multiple switching or when creating multiple methods with different switching timings. It is also possible to create a method during analysis using the Offline Editor menus.

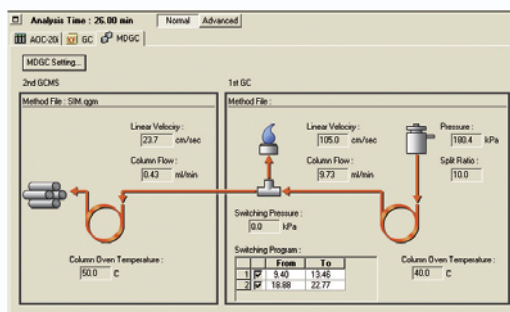

MDGC Analysis Conditions Display Window

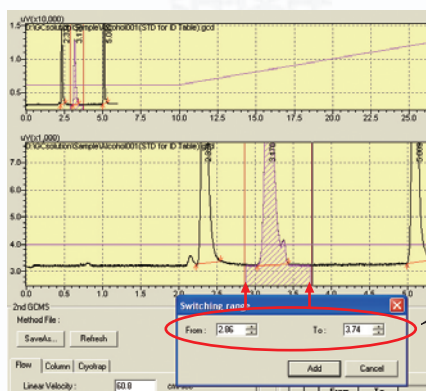

If you double-click at one of the positions indicated with an arrow, the switching (heart-cutting) for that interval is set.

Switching Setting Window

## High-Separation Capability Achieved with 2GC System

In the analysis of complex samples, because high-separation performance is required, the MDGC/GCMS-2010 uses a dual-oven system consisting of two GC instruments of high-separation capability set up in parallel.

With a single-oven system, at the time the peak to be heart-cut is eluted from the 1st column, the temperature of the column oven is often already high. In this state, even with the separation capability of the 2nd column, the results are lower than would be possible if the temperature of the column oven had been low at the time of introduction to the 2nd column. With the dual-oven system, however, because the peak can be introduced to the 2nd column while its temperature is low, high-separation capability is attained.

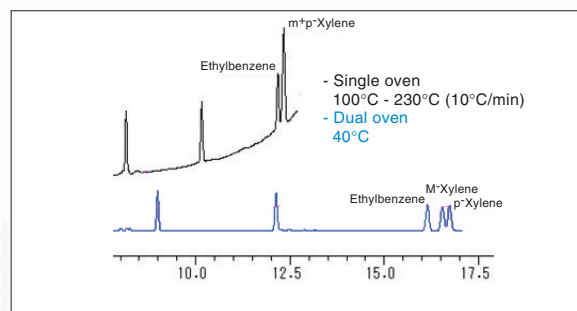

With a single oven, the temperature of the 2nd column is high, and the separation capability is consequently low.

## High-Precision Flow Control with AFC

The pressure and flow rate of the carrier gas and switching gas are electronically controlled with an AFC (Advanced Flow Controller) and an APC (Advanced Pressure Controller). The resulting high-precision pressure and flow-rate control ensures superior reproducibility of analytical conditions, such as column inlet pressure and split ratio. It is also possible to use pressure programs and split-ratio programs.



Advanced Flow Controller AFC-2010

# Greater Ease of Maintenance

## Simple Part Replacement

The switching element is secured to the front of the GC oven at the top, making it easy to replace columns and change connections to detectors and pretreatment systems. Also, stainless steel ferrules with

high heat resistance are used for the column connections, so the additional tightening required with conventional Vespel ferrules is not necessary, and burning does not occur.

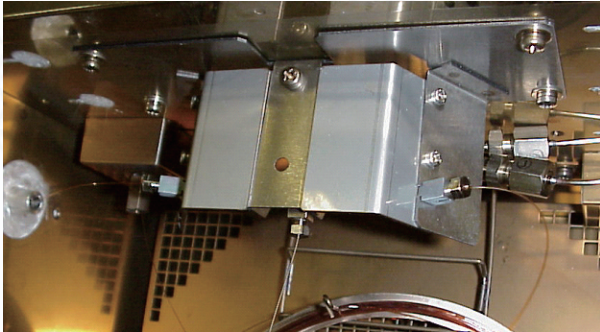

GC Oven Interior



SiTite® Ferrule



Switching Element

## Simple Switching to Conventional GC/GCMS

When not using the MDGC-2010 as an MDGC system, changing the column and detector connections makes it possible to use the GC and GCMS components as independent systems.

MDGCsolution preserves configuration settings independently from the GC/GCMS control software product, GC/GCMSsolution, so it can be used independently.



MDGCsolution



Used as MDGC System



GCMSanalysis



GCsolution



Used as GC System and GCMS System



## Configuration for MDGC System

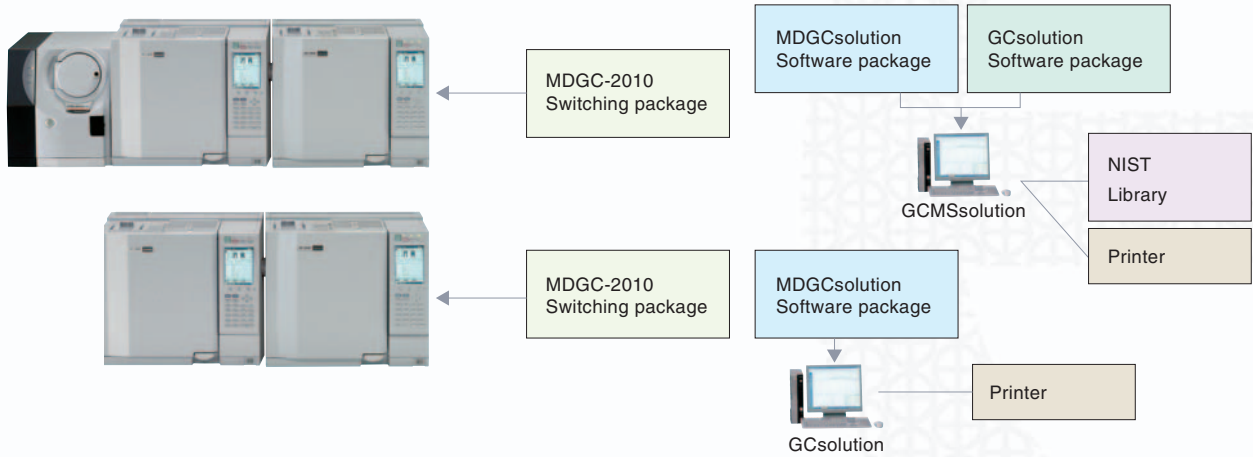

## A Wide Variety of Optional Systems

In addition to GCMS, various other detectors, such as an FID or FPD, can be used with the MDGC/GCMS-2010. For example, a headspace sampler and thermal desorption system can be connected and controlled as a pretreatment system.

\*Available by special order.

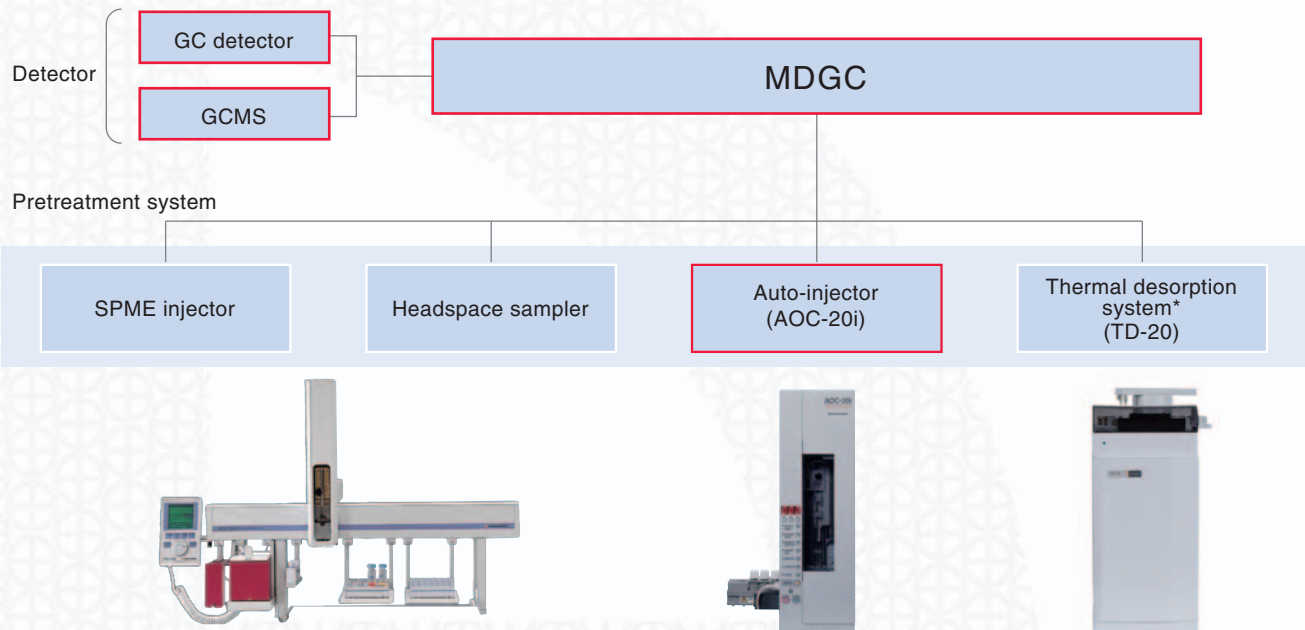

# Petroleum Analysis

## Batch Analysis of Oxygenated Components in Gasoline

With gasoline, a large number of hydrocarbon peaks are eluted, making it difficult to completely separate oxygenated compounds, such as the alcohols that have been added in recent years, using GC-FID. Improving separation using MDGC analysis enables the analysis of components for

which separation and quantitation would be difficult using conventional FID.

The analysis of the 13 components specified by ASTM D 4815-99\* is described below.

\*Standard Test Method for Determination of MTBE, ETBE, TAME, DIPE, tertiary-Amyl Alcohol and C1 to C4 Alcohols in Gasoline by Gas Chromatography

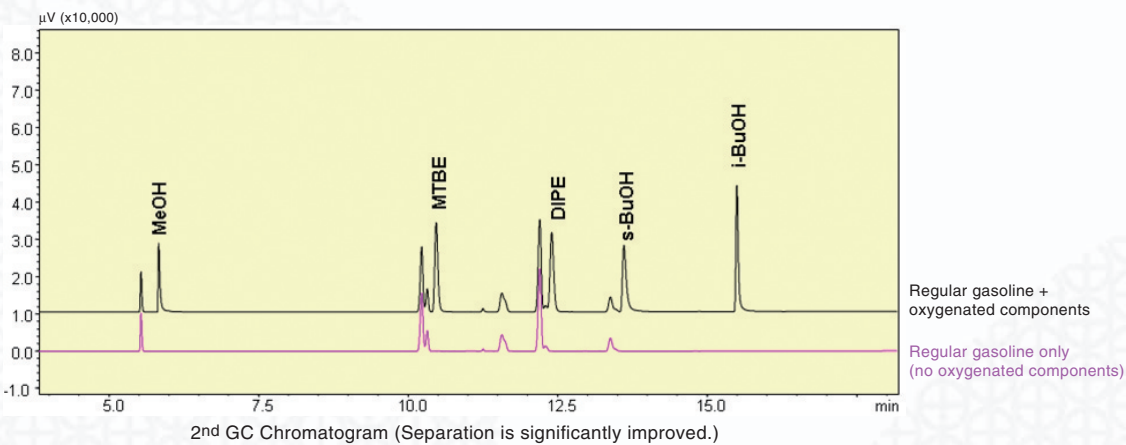
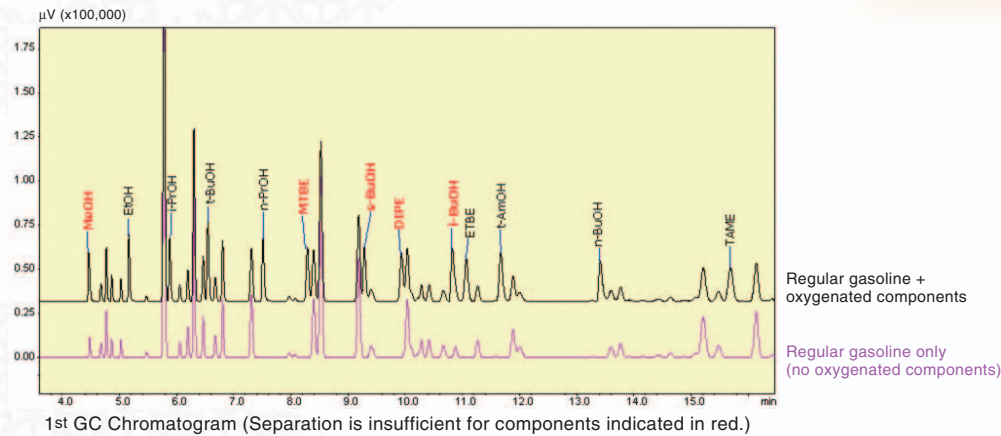

### Separation of MeOH in 1st Column

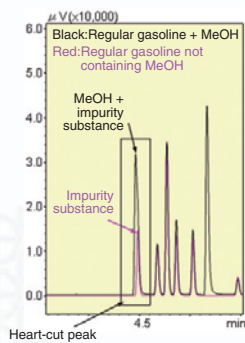

### Separation of MeOH in 2nd Column

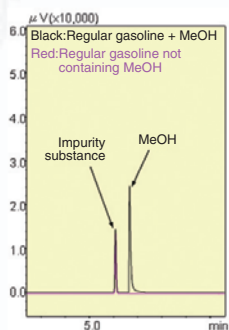

MeOH and the impurity substance are completely separated.

### Analytical Conditions

- 1<sup>st</sup>Column : Rtx-1
- 2<sup>nd</sup>Column : DB-1701
- Switching : 4.42 ~ 4.60 min
- 8.21 ~ 8.40 min
- 9.22 ~ 9.50 min
- 9.85 ~ 10.05 min
- 10.75 ~ 10.98 min

# Fragrance Analysis

## Batch Analysis of Fragrance Components in Essential Oil

Aromatic analysis, in which large numbers of matrices are contained in the samples, is a field where MDGC analysis demonstrates its effectiveness. Combining nonpolar and polar columns enables the separation of aromatic

components and impurity substances. Also, because no fatty acid esters with high boiling points are introduced into the polar column, the analysis time is reduced.

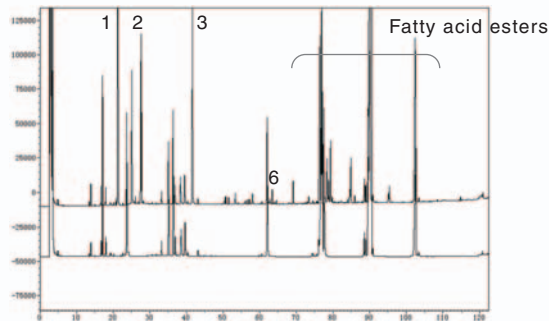
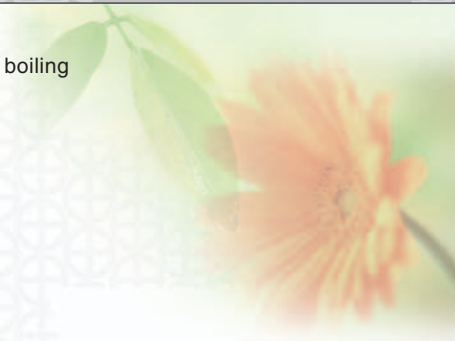

Analysis results for cologne (1st GC): Top: Standby mode  
Bottom: Cut mode

1<sup>st</sup>Column : Rtx-5 0.25mm x 30m df=0.25µm  
Oven temp : 50°C-1.5°C/min-260°C(10min)  
Injector : 250°C Split 1/10  
Monitor FID : 280°C  
2<sup>nd</sup>Column : StabilWAX 0.25mm x 30m df=0.5µm  
Oven temp : 45°C(12min)-1.5°C/min-180°C(10min)  
MS : 250°C scan m/z-20-600

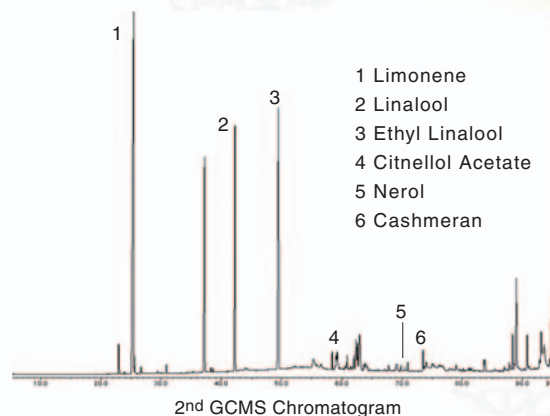

- 1 Limonene
- 2 Linalool
- 3 Ethyl Linalool
- 4 Citnellool Acetate
- 5 Nerol
- 6 Cashmeran

## Multi Switching Analysis of Essential Oil

In the analysis of Essential Oil, many compounds decide the character of fragrance. In the example below, important 8 chiral compounds in bergamot oil are separated into 15 peaks.

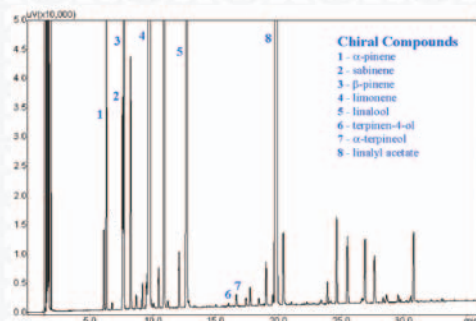

- Chiral Compounds**
- 1 - α-pinene
  - 2 - sabinene
  - 3 - β-pinene
  - 4 - limonene
  - 5 - linalool
  - 6 - terpinen-4-ol
  - 7 - α-terpineol
  - 8 - linalyl acetate

1<sup>st</sup> Column : MEGA SE-52 0.25 x 25m df=0.25µm  
Oven temp : 50°C - 280°C (3°C/min)  
Injector : 250°C  
Split ratio : 1 : 100.  
Monitor FID : 290°C  
H<sub>2</sub>: 50 mL/min, Air: 400 mL/min, Make-up: 0mL/min  
Switching : 8 times  
2<sup>nd</sup> Column : MEGA DetTBuSiliilBeta 0.25 x 25m df=0.25µm  
Oven temp : 45°C (12.00 min) - 180°C (2°C/min)

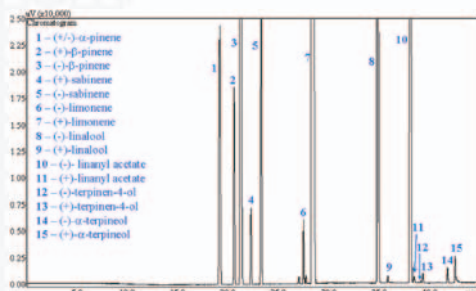

- 1 - (+)-α-pinene
- 2 - (+)-β-pinene
- 3 - (-)-β-pinene
- 4 - (+)-sabinene
- 5 - (-)-sabinene
- 6 - (-)-limonene
- 7 - (+)-limonene
- 8 - (-)-linalool
- 9 - (+)-linalool
- 10 - (-)-linalyl acetate
- 11 - (+)-linalyl acetate
- 12 - (-)-terpinen-4-ol
- 13 - (+)-terpinen-4-ol
- 14 - (-)-α-terpineol
- 15 - (+)-α-terpineol

1<sup>st</sup> GC Chromatogram  
8 compounds are switched onto the 2<sup>nd</sup> column.

2<sup>nd</sup> GC Chromatogram  
8 compounds are separated into 15 peaks.



Data by  
Università degli Studi di Messina  
Prof. Luigi Mondello  
Alessandro Casilli  
Peter Quinto Tranchida  
Danilo Sciarrone

## Specifications

Switching method	Multi-Deans switching (flow channel switching based on pressure difference)
Switching element	Switching element subjected to deactivation processing (can be used at temperatures up to 350°C)
Carrier gas control	Electronic control based on AFC
Switching gas control	Electronic control based on APC
Connectable columns	Capillary columns with inner diameter of 0.1 to 0.53 mm (If the detector is a GCMS, the outlet flow rate must not exceed 15 mL/min.)
Column oven temperature	{Room temperature + 4°C} to 350°C
Temperature of connected heater	50°C to 350°C
Connectable detectors	GCMS, FID, FPD, TCD, ECD, FTD (Other detectors must be ordered specially.)
Sample introduction system	AOC-20i, TD-20*, Turbomatrix HS, AOC-5000, etc. (*Specially ordered )
Carrier gas, switching gas	High-purity helium, nitrogen, argon: 970 kPa max.
Software	MDGCsolution, GCsolution, GCMSsolution (when using GCMS)
Software operating environment	Windows XP; Memory: 512 MB min.
Guaranteed operating environment	Constant temperature in the range 18°C to 28°C (humidity: 40% to 70%)
Power supply	4,600 VA (100V, 115V), 6,200 VA (230V)
Size	1,385 (W) x 440 (H) x 530 (D) mm (for GC/GCMS), not including PC

## Example of System Setup

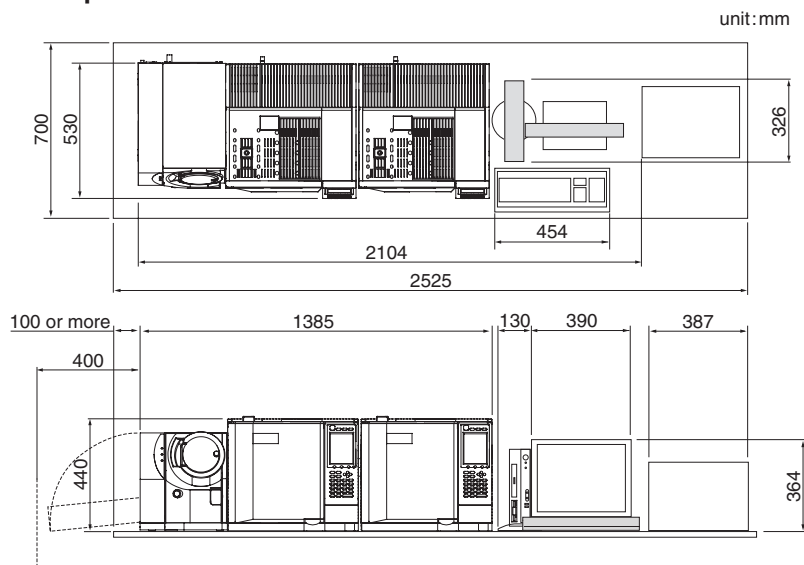

\* The above diagram shows a setup in which the 2nd component is a GCMS instrument. The control PC is positioned alongside the system, and the GCMS rotary pump is installed on the floor.

Founded in 1875, Shimadzu Corporation, a leader in the development of advanced technologies, has a distinguished history of innovation built on the foundation of contributing to society through science and technology. We maintain a global network of sales, service, technical support and applications centers on six continents, and have established long-term relationships with a host of highly trained distributors located in over 100 countries. For information about Shimadzu, and to contact your local office, please visit our Web site at [www.shimadzu.com](http://www.shimadzu.com)



JQA-0376



SHIMADZU CORPORATION. International Marketing Division

3. Kanda-Nishikicho 1-chome, Chiyoda-ku, Tokyo 101-8448, Japan

Phone: 81(3)3219-5641 Fax: 81(3)3219-5710

URL <http://www.shimadzu.com>

Printed in Japan 3295-01801-50ANS

The contents of this brochure are subject to change without notice.